

Article number: 2026480MCR
Description: E+G GN 264
outside diameter 80 mm, 68 mm bore

Measures

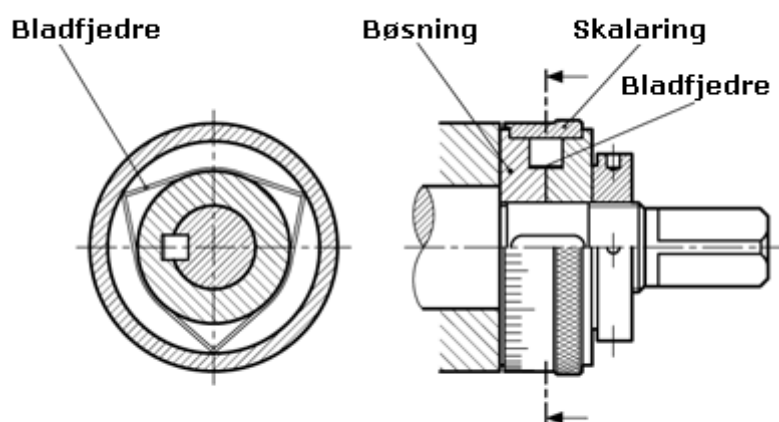

Bore	= -
External diameter	= 80
Handle diameter	= 83
Internal diameter	= 68
Item	= -
Item	= -
Item	= -
Length	= 25.7